

Characteristics

Designation	Model	Rating	Type of switch enclosed & contact arrangement	Cable type / length	Contact	Action force	Material of Rind
Standard type Momentary Action	ID -101	10A 250VAC	Mirco-switch momentary	0.75mm ² ,3C/0.5 meter ,1 meter ~3 meter	1A1B	1.2kg	Plastic
	ID -102	15A 250VAC	IDGW-22B	0.75mm ² ,3C/1 meter ,1.5 meter(米)~2 meter	1A1B	1.1kg	
	IDFS3	10A 250VAC	Mirco-switch momentary	0.75mm ² ,3C/0.5 meter ,1 meter(米)~3 meter	1A1B	1.2kg	Aluminum Cast
	IDFS3S	15A 250VAC	IDGW-22B	0.75mm ² ,3C/1 meter ,1 meter ~3 meter	1A1B	1.1kg	
Standard type Alternate action	ID -105	6A 250VAC	ID 105	0.75mm ² ,2C/1 meter ,1 meter(米)~2 meter	PUSH ON PUSH OFF	2kg	Plastic
	ID -106	6A 250VAC	ID 105	0.75mm ² ,3C/1 meter	PUSH 1A PUSH 1B	1.5kg	
Mini foot switch Front end push	ID -201	10A 250VAC	Mirco-switch momentary	0.5mm ² ,3C/1 meter ~3 meter	1A1B	0.7kg	Plastic
	ID -01	10A 250VAC	Mirco-switch momentary	0.5mm ² ,3C/1 meter ~3 meter	1A1B	0.7kg	
	IDFS-1	10A 250VAC	Mirco-switch momentary	0.5mm ² ,3C/1 meter ~3 meter	1A1B	0.9kg	Iron
Protective guard foot switch	ID -302	15A 250VAC	IDGW-22B	Accessory: Cable gland (No cable)	1A1B	3.2kg	Aluminum Cast
	ID -304	15A 250VAC	IDGW-22BX2		2A2B	3.2kg	
	ID -305	6A 250VAC	ID 105		PUSH ON PUSH OFF	3.1kg	
	ID -306	6A 250VAC	ID -105		PUSH 1A PUSH 1B	3.5kg	
	ID -502	15A250VAC	IDGW-22B		1A1B	3.2kg	
	ID -504	15A250VAC	IDGW-22B		2A2B	3.2kg	
	ID -602	15A250VAC	Button spring type		2*1A1B	2.8kg	
Large type	ID -702	15A250VAC	IDGW-22B	2*1A1B	3.2kg		
	ID -402	15A250VAC	IDGW-22B	1A1B	3.2kg		
	ID -404	15A 250VAC	IDGW-22BX2	2A2B	3.2kg		
	ID -802	15A 250VAC	IDGW-22B	2*1A1B	3.2kg		

Appearance and Dimension

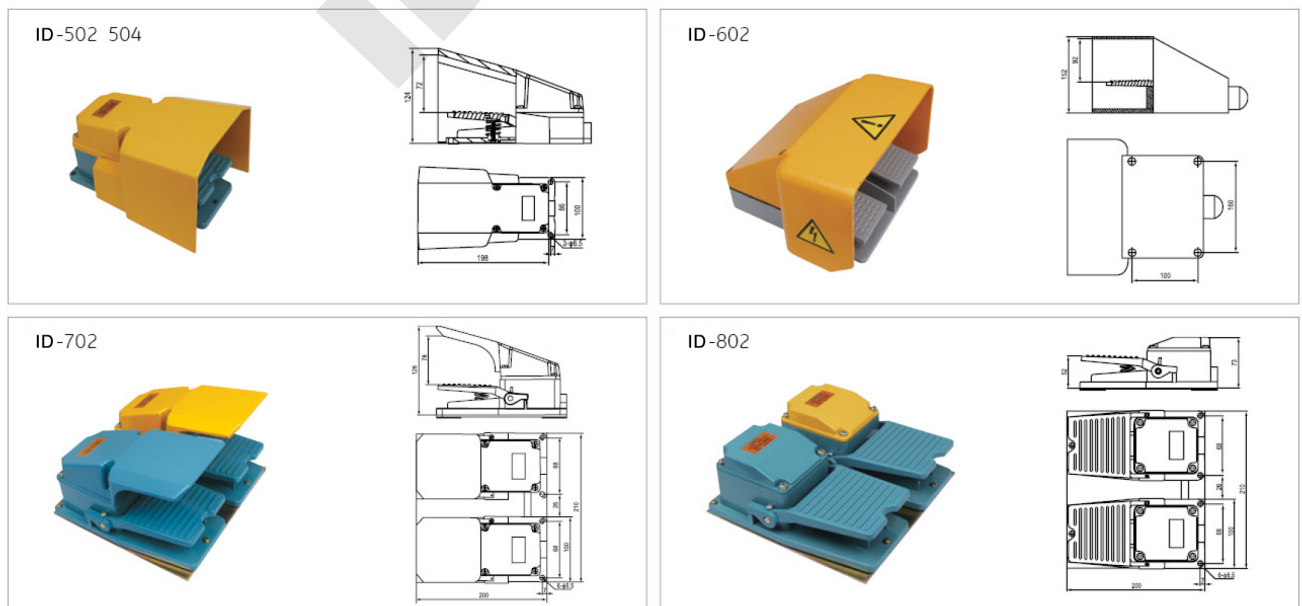

ID-101 102 105

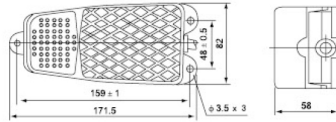

ID-201 202

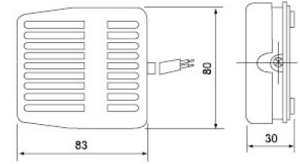

IDFS -2

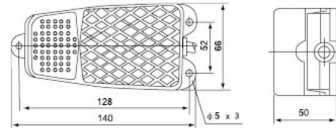

IDFS -1(P)

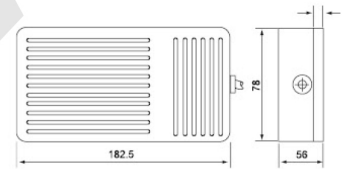

IDFS -3

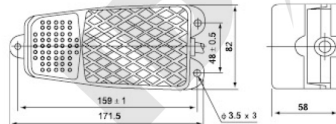

IDFS -1(M)

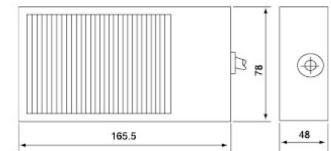

ID-302

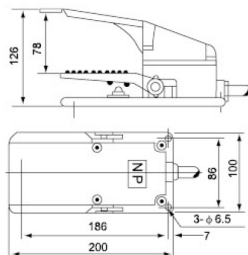

ID-402

